



Ovalna kičma

ABL kičme za kablove ovalnog oblika sprečavaju oštećenje na kablovima i njihovo zapetljavanje. Sa njima svaka kancelarija ostaje uredna i organizovana. U ponudi su kičme u crnoj, beloj ili sivoj boji.

- Organizuje i sakriva kablove, ujedno ih štiteći od oštećenja
- 16 segmenata
- Baza sa tegom za dodatnu stabilnost
- Pregrade unutar kičme omogućavaju zaseban prolaz za svaki od kablova
- Jednostavne za montažu: ne zahtevaju upotrebu alata ili posebnih veština

DOSTUPNE BOJE





Ovalna kičma

DIMENZIJE I INSTALACIJA

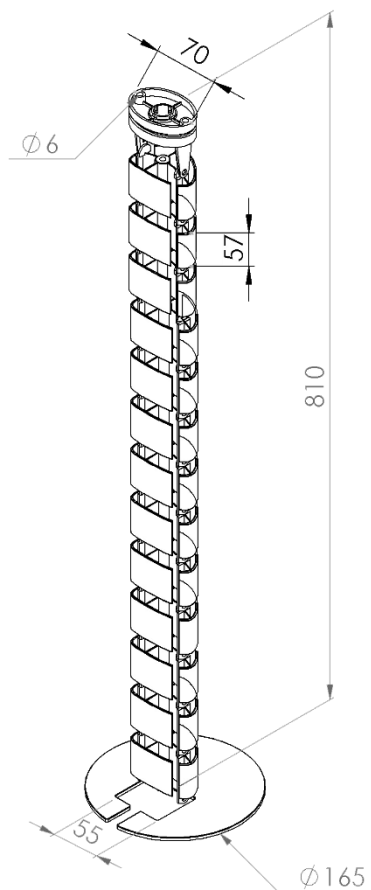

Pakovanje sadrži:

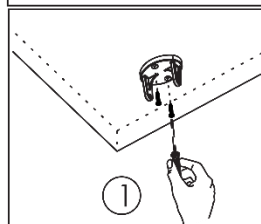

1. Fiksirajte gornji nosač za unutrašnju stranu ploče stola pomoću vijaka.

2. Spojite nosač kablova sa gornjim fiksatorom.

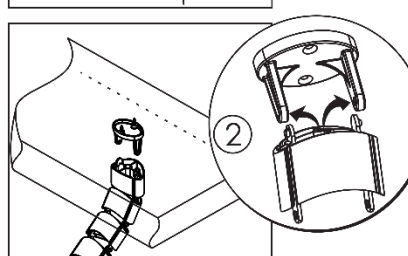



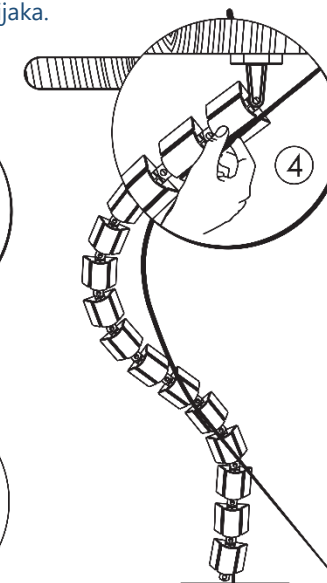
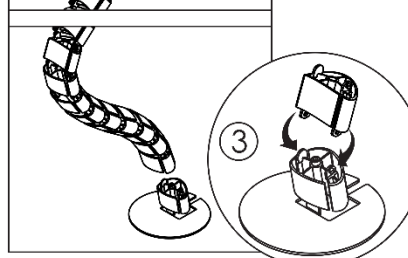

3. Spojite nosač kablova sa bazom.



4. Provcite kablove kroz organizator

DIMENZIJE AMBALAŽE

				
	9cm	24cm	24.5cm	0,95kg