



















CONFERENCE

CONFERENCE je modularna kutija kojoj možete pristupiti sa obe strane. Opseg konekcija koji uključuje USB punjač, data i media konekcije zadovoljiće potrebe svake konferencijske sale.



TEHNIČKE KARAKTERISTIKE

STRUJA	DOSTUPNI TIPOVI UTIČNICA	DOSTUPNE KONEKCIJE
Voltaža: 230V~AC Amperaža: 16A max frekvencija: 50-60 Hz Temperatura: 0-40°C Relativna vlažnost: 0-95 °C	 TIP F	 RJ45
	 TIP G	 USB 3.0
	 TIP L	 HDMI
	 TIP E	 VGA
	 TIP B	 AUDIO
	 USB PUNJAC	
		
		
		
		



UPOTREBA



DOSTUPNE BOJE





CONFERENCE

DIMENZIJE I MONTAŽA

Conference je dostupan u tri dimenzije kućišta – MIN, MID i MAX.

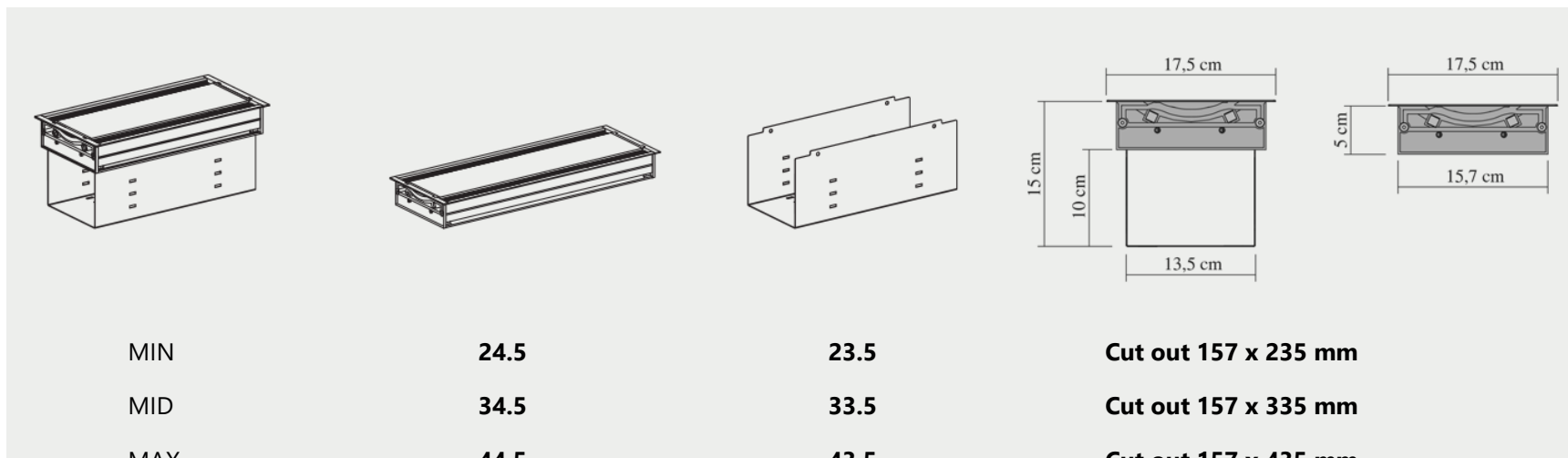

MIN	24.5	23.5	Cut out 157 x 235 mm
MID	34.5	33.5	Cut out 157 x 335 mm
MAX	44.5	43.5	Cut out 157 x 435 mm

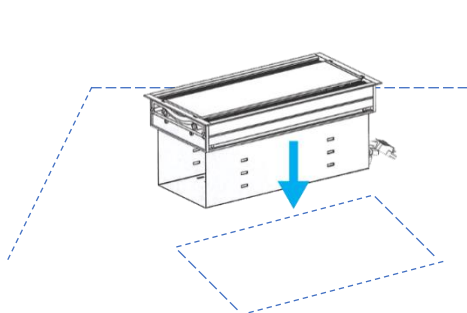

OPCIJA 1

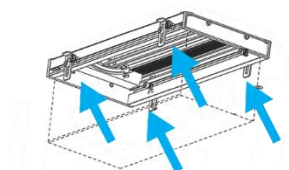

M5x8

OPCIJA 2

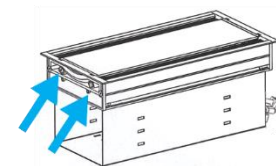

Napraviti otvor u stolu prema dimenzijama iz tabele. Ukoliko je ploča stola debljine do 36mm, fiksiranje se vrši pomoću fiksatora i zavrtnja (opcija 1). Ukoliko je ploča stola deblja od 36mm, modul se fiksira u ploču kroz otvore na bočnim stranama. U ovom slučaju, otvore za fiksiranje treba napraviti sa unutrašnje strane uređaja (opcija 2).



CONFERENCE

